

# Washer Dryer

## User Manual

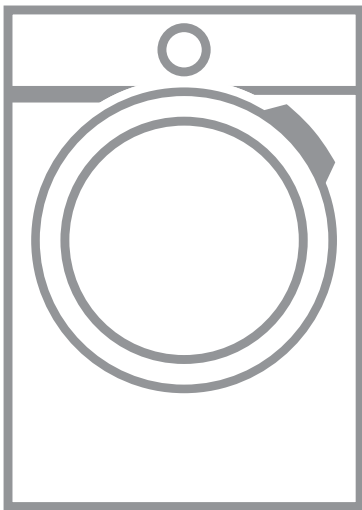

- Do not connection/disconnect the power supply plug from the socket with wet hands
- Only disconnect the power supply plug from the socket by taking hold of the plug itself, never by pulling on the lead.

## DESCRIPTION OF CONTROLS

### CONTROL PANEL

All the appliance's control and monitoring devices are placed together on the front panel.

**Display:** shows the settings (spin speed, cycle status, flexi time, maximum recommended weight, drying levels, child lock, clean programme). The settings can be modified using the buttons underneath.

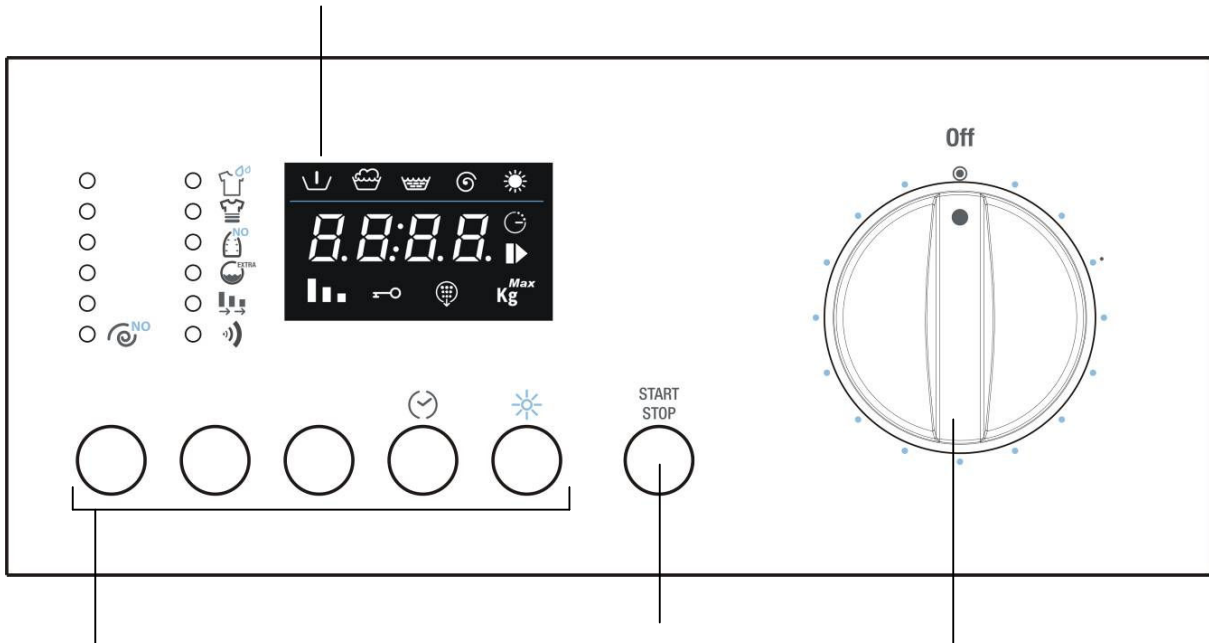

Buttons (from left to right):  
**Spin speed selection**  
**Option selection**  
**Confirm option**  
**Delay Timer**  
**Drying**























**Start/Pause button:**  
 For starting and stopping working cycles.

**Programme Selector**  
 For switching the washer-dryer on and off and selecting programmes. Can be turned in either direction. Does not turn while programmes are in progress.

## USING THE APPLIANCE FOR WASHING

### PREPARING THE ITEMS FOR WASHING

- Subdivide the items for washing by fabric type and colour fastness.
- Wash white and coloured items separately. New coloured items should be washed separately the first time. Normally, items carry labels with washing instructions. The following is a short description of the symbols used on these labels.

WASHING		BLEACHING			
	Machine wash at max. 90°C	 Bleaching allowed		 Do not bleach	
	Machine wash at max. 60°C				
		IRONING			
	Machine wash at max. 40°C	 Hot iron	 Warm iron	 Cool iron	 Do not iron
	Machine wash at max. 30°C				
		DRY CLEANING			
	Machine wash, delicate cycle at max. 60°C	 Any solvent	 Any solvent except trichloroethylene	 Petroleum solvent and R113	 Do not dry clean
	Machine wash, delicate cycle at max. 40°C				
	Machine wash, delicate cycle at max. 30°C				
		DRYING			
	Hand wash	 High temperature	 Less than 60°C	 Do not tumble dry	
	Do not wash				

#### Warning!

- Do not wash unhemmed or torn items as they may fray.
- Unrelated items in the wash may damage the garments or parts of the washer-dryer. So: empty pockets and turn them inside-out, and remove wheels from curtains or wrap them in a mesh bag.
- Wash very small items (belts, handkerchiefs, socks, padded bras, etc.) in a white canvas bag. Fasten press-studs and zips and sew on loose buttons.
- The use of modern detergents and the correct washing temperature is generally sufficient to remove stains from fabrics. However, some difficult stains such as grass, fruit, egg, blood, rust, ballpoint pen, etc. should be dealt with before washing. **Depending on the type of fabric, there are a large number of commercial stain removers on the market. In all cases, stains should be cleaned or diluted at once, since the older they are, the harder they are to remove.**
- Failure to comply with washing guidance symbols may result in damage to the items washed.**

**Wool** – Only wool marked as pure new wool, with the  mark, or labelled "shrink-proof, machine-washable" can be washed in a washing machine on the specific programme; other types of wool should be hand-washed or dry-cleaned. **OPENING THE DOOR**

The appliance is fitted with a safety device which prevents the door from being opened while the programme is in progress.

- Check that all the water has been drained from the tank and the drum is at a standstill.

#### Warning!

- If the washing programme is interrupted, it will be from 3 to 15 minutes before the door can be opened, depending on the temperature reached inside the appliance.

#### Warning!

**The water may still be boiling hot if the wash was at high temperature. Do not open the door if there is still water in the drum!**

### LOADS OF WASHING

As far as possible, **to save electricity, it is more economical to wash complete loads of the various types of fabric.** Shake out the laundry before loading, and alternate large and small items. It is best to weight the load the first few times, after which you will be able to rely on your experience.

## LOADING THE ITEMS FOR WASHING

1. Open the door and load the laundry, distributing it evenly over the drum, with items opened out and not bundled together; if possible, large and small items should be well mixed.
2. The washing machine covered by this manual can be **loaded with up to 7kg** of laundry for each wash. If this weight is exceeded, the washing results will be poor and the appliance may malfunction.
3. **To save energy it is more economical to wash full loads** of the various types of fabric, following the guidance on quantities provided in the "Programmes Table" supplied in this manual.
4. Close the door by pressing against the frame until you hear it click shut. Take care not to trap items of laundry between the door and the rubber gasket.

### Warning!

- If the door is not properly closed, a safety device prevents the washer-dryer from starting.
- **Do not exceed the maximum load: overloading adversely affects washing results.**

## ADDING DETERGENT AND ADDITIVE

The internal tray comprises three compartments, marked with the symbols



prewash detergent



main wash detergent



for fabric conditioner, starch, additives, etc. (e.g. treatment products). The additives are added to the washing tank automatically during the final rinse.

The main wash detergent compartment has a tang allowing the use of liquid detergent. To insert it, pull it towards the front and then lower it.

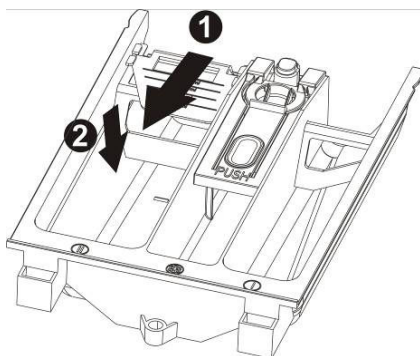

Following the recommendations in the "Programmes Table" supplied with this manual, place the detergent and any additives in the drawer before the start of the programme.

**Never fill with liquids above the maximum level marked;** otherwise the trays will empty too quickly.

Before pouring dense additives into the container, dilute with a little water to ensure they do not clog the outlet.

Use only low-foam detergents suitable for use in a washer-dryer.

**The amount of detergent must be decided in relation of the hardness of the water, the type and quantity of items loaded, and their degree of dirt.**

This will provide the desired effect with optimal detergent consumption.

tion.

On detergent packs the recommended dose is indicated for 4 levels of water hardness and for loads of 4-5 kg of laundry with average dirt levels.

Request information about the water's hardness from your water supply company.

### Water hardness

Level of hardness	French degrees fH	German degrees dH
Soft	Up to 15°	Up to 8°
Medium	15° - 25°	8° - 14°
Hard	25° - 40°	14° - 22°
Very hard	More than 40°	More than 22°

## POWDER DETERGENT DOSES

### Laundry with normal dirt

1. Choose a programme without prewash.
2. Pour the total amount of detergent shown on the pack into the main wash compartment of the detergent drawer.

### Very dirty laundry

1. Choose a programme with prewash.
2. Place ¼ of the recommended amount of detergent in the prewash compartment of the detergent drawer and ¾ of the detergent in the wash compartment.

### Warning!

- If no recommended doses are provided, for delicate items in synthetic fibre use from ½ to 2/3 of the recommended dose for washing tough cotton fabrics.
- Only neutral detergents recommended for wool should be used on the wool programme.
- Use the doses recommended by the detergent producer.

## LIQUID DETERGENT DOSES

1. Pour the dose required into the measuring cap supplied with the bottle of liquid detergent and place it in the drum, or use the main wash compartment of the detergent drawer, fitting the insert provided.
2. The scale on the red insert is intended as an aid when deciding the dose of liquid detergent.

### Warning!

- Liquid detergents can be used, at the doses recommended by the producer, **only for the main wash, i.e. in all programmes without prewash.**

## DESCALERS

Descalers can be added to the prewash and main wash compartments as recommended by their producers. Place the detergent in the compartments first, followed by the descaler.

## PROGRAMMES AND FUNCTIONS

For advice on selecting programmes in relation to the type of fabric, refer to the "Programmes Table", supplied with this manual (inside the bag of accessories).

## SWITCHING ON THE APPLIANCE AND SELECTING THE WASHING PROGRAMME

To switch on the appliance and select the programme, proceed as follows:

1. Turn the programmes knob in either direction. This switches on the washer-dryer.
2. Select the washing programme. The time left to the end of the programme and the maximum recommended weight for the selected programme alternate on the display. The symbols on the display light up to identify the information shown.
3. The default spin speed values are shown. The initial settings can be modified using the button underneath the sequence of spin speeds.
4. If spin speed  is set, there will be no spin cycle and the appliance will stop with the tank full. If this value is set the appliance does not perform the final spin and the washing programme ends with water in the tank.

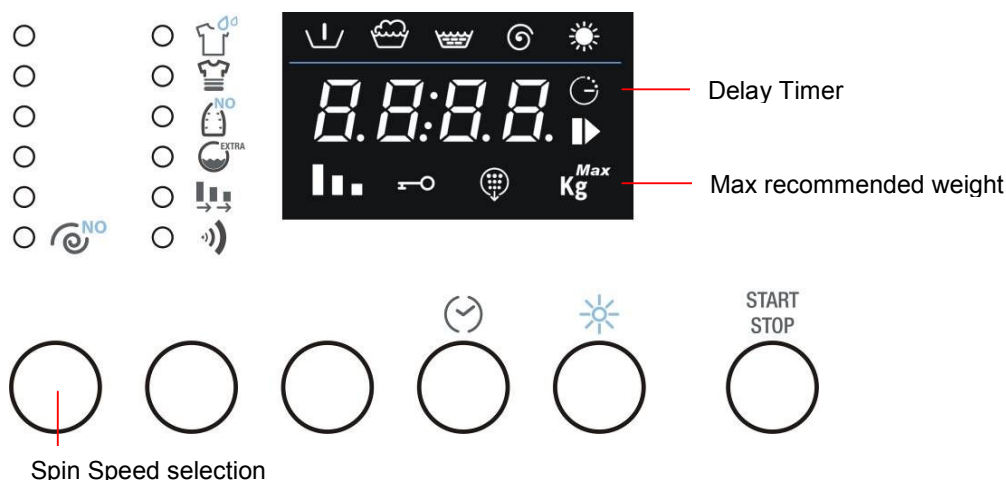

## SELECTING AND CONFIRMING OPTIONS

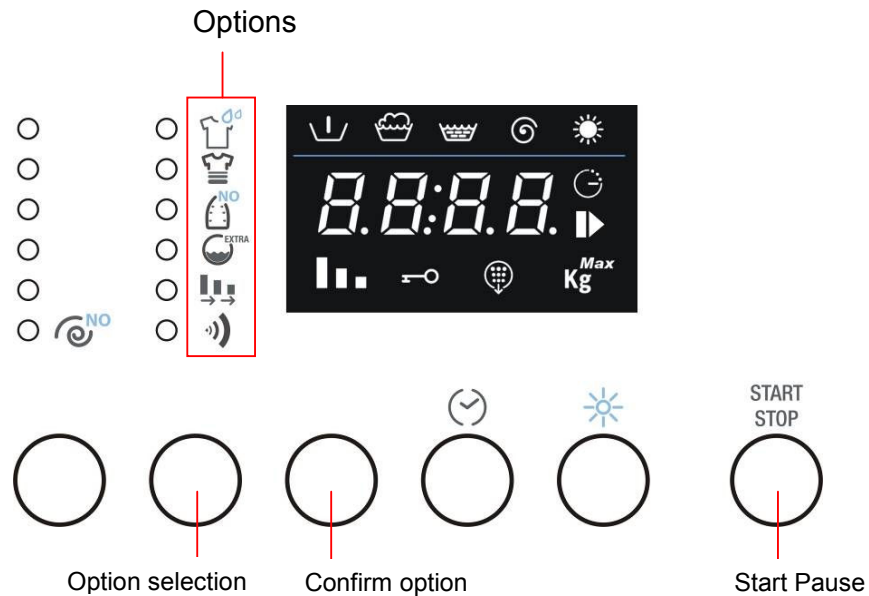

- The Option Selection button can be used to select the following options in sequence (from the top down):

  - Prewash:** adds a stage before the main wash, lasting about 20 minutes at a temperature of 35°C. Suitable for loads of particularly dirty items.
  - Intensive:** the max. temperature is changed to 60°C and the washing stage is extended to increase the effectiveness of the enzymes in the detergents. Suitable for delicate but dirty items.
  - Easy iron:** produces items which are less creased and easy to iron.
  - Water plus:** Increases the amount of water used for washing and rinses.
  - In alternative **Extra rinse:** this option adds a rinse to the selected washing programme.
  - Flexi Time:** reduces the duration of the cycle. The symbol is completely illuminated with the initial duration of the selected programme. Once the option has been selected the cycle duration can be further reduced to an intermediate setting and a minimum setting and then returned to the initial duration by repeated pressing of the Set button
  - In alternative **Rapid:** reduces the duration of the washing cycle. Suitable for small amounts of laundry with only light dirt.
  - Buzzer:** sets whether or not the buzzer will sound at the end of the cycle. The appliance comes with the buzzer function "on".
- To confirm the selected option, simply press the Confirm options button and the LED of the option remains on.
- To delete an option selection, simply return to the option with the Selection button and press the Confirm options button. To annul all the options previously selected in a single operation, simply hold down the Confirm options button for 4 seconds.
- The Buzzer option retains its "on" or "off" status for subsequent cycles. It is only automatically switched to "off" if the Night Wash programme is chosen.

### TIME REMAINING

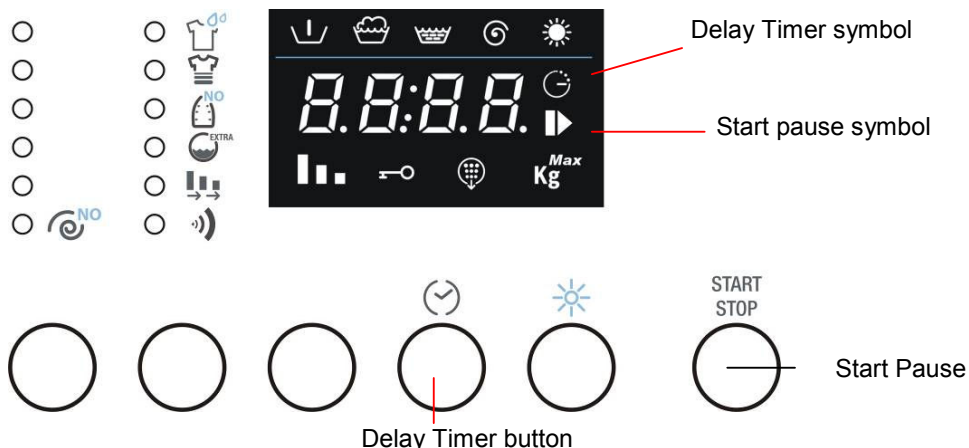

1. The Delay Timer can be pressed repeatedly to select the time after which the washing programme will end. The time left before the end of the cycle calculates the initial duration of the washing/drying cycle, the settings made (temperature, spin speed and options) which may shorten or lengthen the cycle's initial duration, and the delay time the user wishes to add before the cycle starts.
2. After the Delay Timer function has been set, the symbol on the display remains on.
3. To annul the Delay Timer function, keep pressing the button repeatedly until the display shows 0.
4. The Start Pause symbol flashes on and off until the cycle starts. After the cycle starts, the symbol remains constantly lit.

### STARTING THE WASHING PROGRAMME

1. To start the washing programme after making your personal settings, press the Start Pause button.
2. Once the cycle has started, the display shows the time remaining before the end of the cycle and the Start Pause symbol on the display is constantly on.
3. During performance of the washing/drying programme, the symbols which identify the various phases light up:

Cycle phase symbols: Prewash, wash, rinses, final spin and dry.

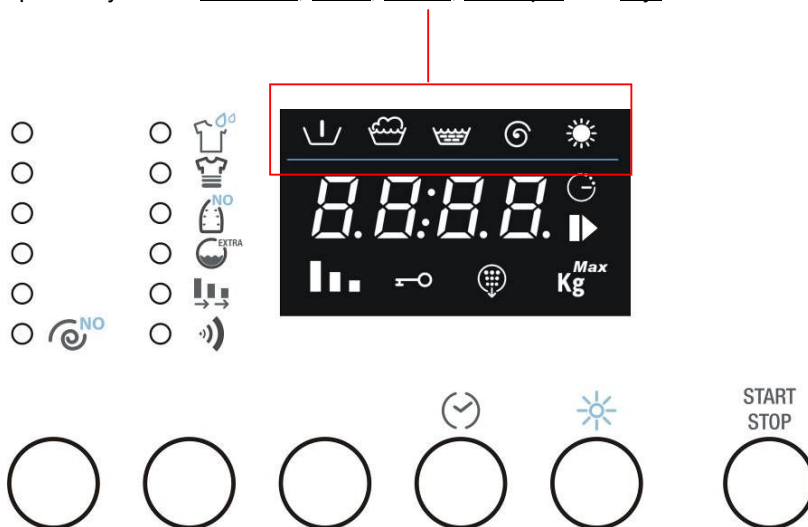

## INTERRUPTING OR CHANGING THE WASHING PROGRAMME

The washing programme in progress can be interrupted at any moment:

1. press the "Start/Pause" button for about 3 seconds: the display shows the word PAUS (for 1 second) alternating with the time remaining until the end of the cycle (for 1 second). The Start/Pause light flashes on and off.  
Programmes can also be interrupted by turning the programme/temperature setting knob while the cycle is in progress.
2. To change the washing programme, simply turn the programme knob to select the new programme; there is no need to set the appliance in pause status. The new cycle will be carried out completely, beginning from the start. If the tank had already been filled with water during the previous cycle, the water intake phase will be omitted from the new programme.
3. To restart the cycle, press the Start-Pause button again.

## PROGRAMME END

Washing/drying programmes are completed automatically. The word END appears on the display and the "Time remaining" light goes out.

1. **Switch the appliance off by turning the programmes knob to OFF**
2. Unload the laundry from the drum.
3. Leave the door ajar to allow the interior of the washer-dryer to dry out.
4. **Turn off the water intake tap.**

If during the initial spin speed setting stage, the "no spin" mode with stop with tank full  (spin speed set as 0) was selected, at the end of the washing programme the word STOP appears on the display, alternating with ---- (spin speed of 0) and the spin light is on.

To proceed with the pump-out and spin, press the spin selection button twice. The appliance restarts the cycle with the pump-out and spin. To select the spin speed required, press the button until the chosen speed is displayed. To pump out the water from the tank without performing the spin, press the spin selection button until the display indicates speed of 0: the pump-out will be run without spin.

## CHILD LOCK

1. When this function is activated, the modification of options, temperatures, spin speed and the washing/drying cycle is not possible while the cycle is in progress.

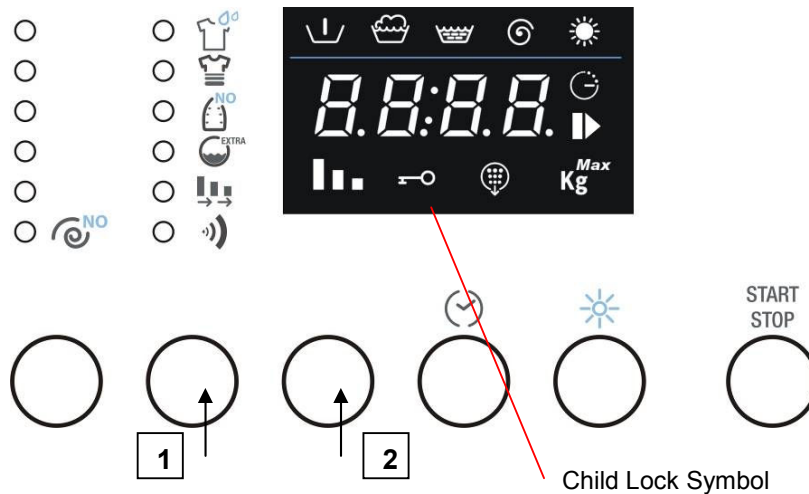

2. To activate the Child Lock, press the Option selection button and hold it down. Also press the Confirm options button within 3 seconds.
3. The Child Lock symbol lights up to show that the function has been activated.
4. Repeat the same procedure to deactivate the function.



## OPENING THE APPLIANCE IN AN EMERGENCY

In the event of a power failure, the door is opened using the mechanical release device activated by means of the lever in the bottom of the appliance:

- Turn the knob to Off and disconnect the power supply plug from the socket.
- Drain off the water (see point 6.4)
- Pull the lever down and open the door.

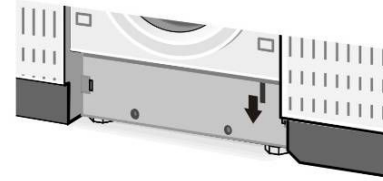

**Warning, scolding hazard:** before opening the door, check that the appliance does not contain boiling hot water and detergent which may pour out and cause injury when the door is opened.

**Warning:** do not open the door using the emergency release lever while the drum is turning.

## USING THE APPLIANCE FOR DRYING

### GENERAL

**During drying cycles, the water tap must be turned on and the drain hose correctly positioned.**

This appliance can be set to perform wash only, dry only and wash-and-dry programmes.

In the wash-and-dry programme, the appliance switches from washing to drying automatically, with no need to use the controls (at the end of the wash) to obtain the complete cycle.

#### Attention

- Only dry laundry or garments washed in an aqueous solution and suitable for tumble drying.
- Do not dry fabrics which have been dry cleaned or had stains removed with chemical solvents, wool or wool blend fabrics which will be shrunk by the heat, very delicate fabrics such as silk and synthetic curtains, fabrics which may easily lose threads such as woollen yarn, padding and loose-pile mats, or articles which contain foam rubber or similar elastomers.
- **Loads of laundry placed in the washer-dryer for drying must not exceed 4 Kg in weight.** The washer-dryer is constructed to give the best results with loads which do not exceed 4 kg of dry weight of laundry.
- When washing programmes for resistant fabrics are set, drying automatically takes place at 90°C (normal drying).
- In washing programmes for delicate fabrics, drying automatically takes place at 60°C (gentle drying). Therefore, in automatic wash-and-dry programmes, the drying programme will depend on the washing programme selected.
- In drying only programmes, the laundry must first have been washed and spun-dried.
- After drying particularly fluffy items such as new terry towels, the "Rinse" program should be carried out to ensure that any deposits left by the fabric are removed, and are not deposited on the clothes in the next wash.

**Important** – Do not dry delicate fabrics that will not withstand a temperature of 60°C or any fabrics which will not withstand the selected temperature.

#### EXTRA DRYING

If the laundry is still too damp at the end of the programme, set a short timed drying programme.

**Warning!** do not over-dry as this may cause creases or shrinkage of garments.

## WASH-AND-DRY PROGRAMME

Automatic washing and drying can be carried out in the tough fabrics (cotton and colours) and synthetic/delicate fabrics programmes. If the wool wash programmes are selected, automatic drying after the wash cannot be set. For automatic washing and drying, the load of laundry **must not exceed 4 kg of cotton or 2 kg of synthetic fabrics**.

Therefore, if the load for washing and drying exceeds the quantities stated above, a wash+dry programme is not recommended; the load will have to be halved after washing and dried in two lots.

To set a **wash-and-dry programme** proceed as follows:

1. Select the **washing programme and make any changes to the default parameters**;
2. Press the dry button to set the drying time required. The display initially shows the maximum time which can be set (2h:40'), which is then gradually reduced to 0h:00'

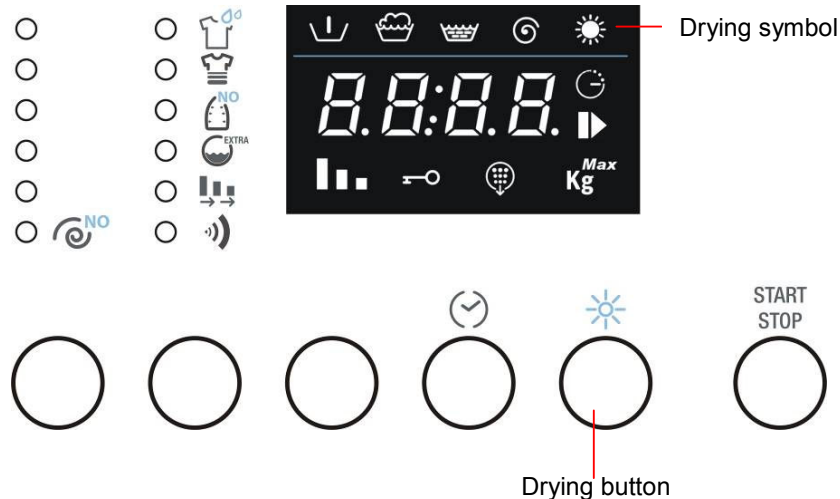

Whether drying will be at the normal temperature (90°C) or the delicate fabrics temperature (60°C) depends on the washing programme set previously.

Once a drying time has been set, the symbol on the display flashes; it remains constantly on once the cycle enters the drying stage.

## DRY ONLY PROGRAMME

1. Turn the appliance off by turning the washing/drying programmes selector knob to OFF.
2. Turn the knob to the drying programme required: Intensive drying: for normal drying (90°C), or Gentle drying: for delicate fabrics (60°C). To find out which symbol identifies each drying programme, refer to the programmes table supplied with the appliance.
3. Press the Dry button repeatedly to set the drying time required (see previous point).
4. Press the "Start-Pause" button to start the drying programme. The display shows the time remaining and the drying symbol LED lights up.

### Attention

- Since no washing programme has been set previously, there are no constraints on selection of the drying programme (normal or gentle). Remember that normal drying is recommended for cotton and coloureds, and gentle drying for synthetic and delicate items.
- For good drying results, the load of laundry **must not exceed 4kg of cotton or 2kg of synthetic fabrics**.

## INTERRUPTING OR CHANGING THE DRYING PROGRAMME

1. The drying programme can be interrupted by the same procedures as the washing programme.
2. To end the programme and remove the laundry, it is best first to cool the load. Use the selector button to set a drying time of 20 minutes. Restart the appliance as described above and the laundry will be ready for removal.

## PROGRAM GUIDE

Programs	Temp. (°C)	Max. Spin (rpm)	Max. washing load (kg)	Max. drying load (kg)	Detergent drawer compartments			Options					Drying after wash if selected	Wash program description	
					Prewash	Wash	Conditioner	Prewash	Intensive	Easy Iron NO	Extra rinse	Rapid			
<b>Cotton and Coloureds</b>	Delicate coloureds with light dirt	Cold	Max	7	4	✓	✓	✓	✓	✓	✓	✓	✓	Normal	Cold wash, rinses and final spin at the selected speed
	Delicate coloureds with normal dirt	40°	Max	7	4	✓	✓	✓	✓	✓	✓	✓	✓	Normal	Wash at 40°C, rinses and final spin at the selected speed
	Tough coloureds with normal dirt	60°	Max	7	4	✓	✓	✓	✓	✓	✓	✓	✓	Normal	Wash at 60°C, rinses and final spin at the selected speed (Standard cycle with only "intensive" option selected)
	Tough coloureds with heavy dirt	90°	Max	7	4	✓	✓	✓	✓	✓	✓	✓	✓	Normal	Wash at 90°C, rinses and final spin at the selected speed
<b>Wool and Delicates</b>	Hand wash	Cold	800	2	-	-	✓	✓	-	-	-	-	-	-	Cold wash, rinses and final spin at the selected speed
	Wool and silk	30°	800	2	-	-	✓	✓	-	-	-	-	-	-	Wash at 30°C, rinses and final spin at the selected speed
<b>Rinse &amp; Spin</b>	-	Max	7	-	-	-	✓	-	-	✓	-	✓	-	Rinse and pump-out only, or pump-out and final spin at the selected speed	
<b>Drain &amp; Spin</b>	-	Max	7	-	-	-	-	-	-	✓	-	✓	-	Pump-out only, or pump-out and final spin at the selected speed	
<b>Synthetics</b>	Items with light dirt	30°	1000	3,5	3,5	✓	✓	✓	✓	✓	-	✓	✓	Delicate	Wash at 30°C, rinses and final spin at the selected speed
	Items with normal dirt	40°	1000	3,5	3,5	✓	✓	✓	✓	✓	-	✓	✓	Delicate	Wash at 40°C, rinses and final spin at the selected speed
<b>Super Fast</b>	Light cotton or delicate fabrics for refreshing	30°	800	2	-	-	✓	✓	-	-	-	-	-	-	Wash at 30°C, rinses and final spin at the selected speed
<b>Mix</b>	Cotton and synthetics with light dirt	30°	1200	3	3	✓	✓	✓	✓	✓	✓	✓	✓	Delicate	Wash at 30°C, rinses and final spin at the selected speed
<b>Drying Programmes</b>	Gentle	60°	Max	-	3	-	-	-	-	-	-	-	-	-	Delicate drying for synthetic and delicate items
	Intensive	90°	Max	-	4	-	-	-	-	-	-	-	-	-	Normal drying for cotton items
	Clean	-	-	-	-	-	-	-	-	-	-	-	-	-	Drying circuit cleaning cycle

✓ Option available



: Options which cannot be selected simultaneously